

# ULTIMATE 1000

SCHEMA TECNICA

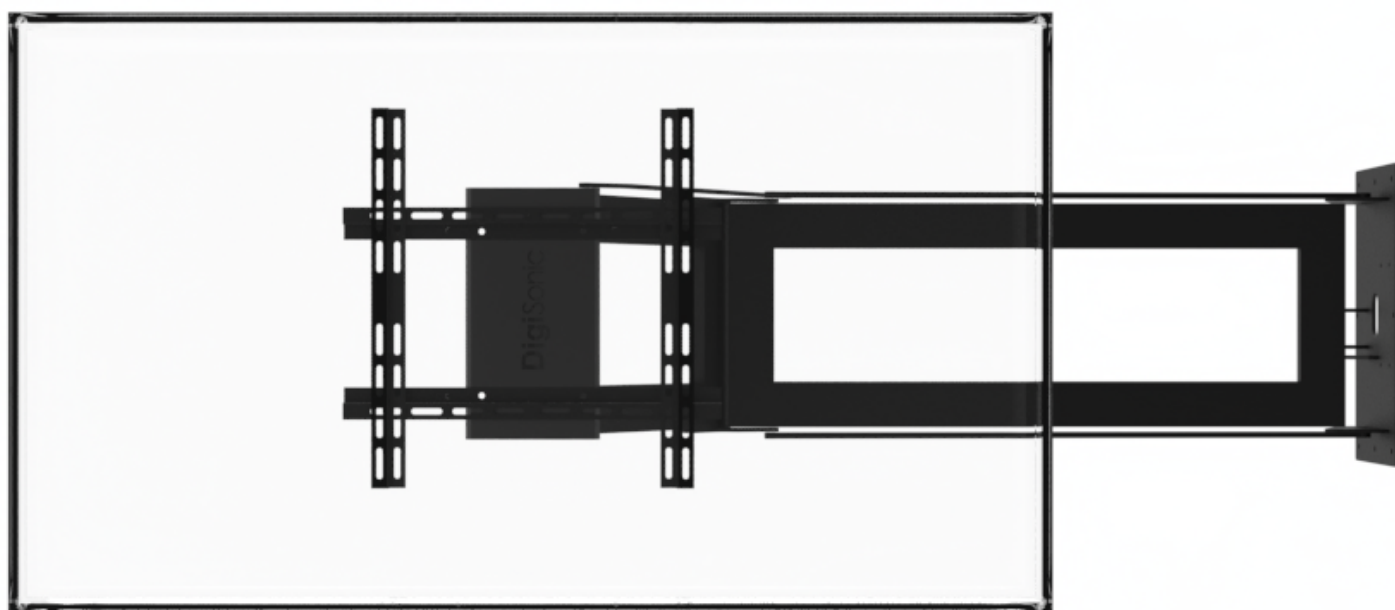

PRESENTIAMO LA STAFFE MOTORIZZATE CHE **PERMETTONO DI SPINGERE IN AVANTI** IL TELEVISORE E DI **APRIRLO A LIBRO FINO A 90°**. PROGETTATA PER ESSERE **INSTALLATA ALL'INTERNO** DI UN RECESSO DELLA PARETE O DENTRO UNA BOISERIE.

## DATI TECNICI:

---

Dimensione del TV	32" - 65"
VESA	200-300-400
Apertura max	90°

## DISEGNO TECNICI:

---

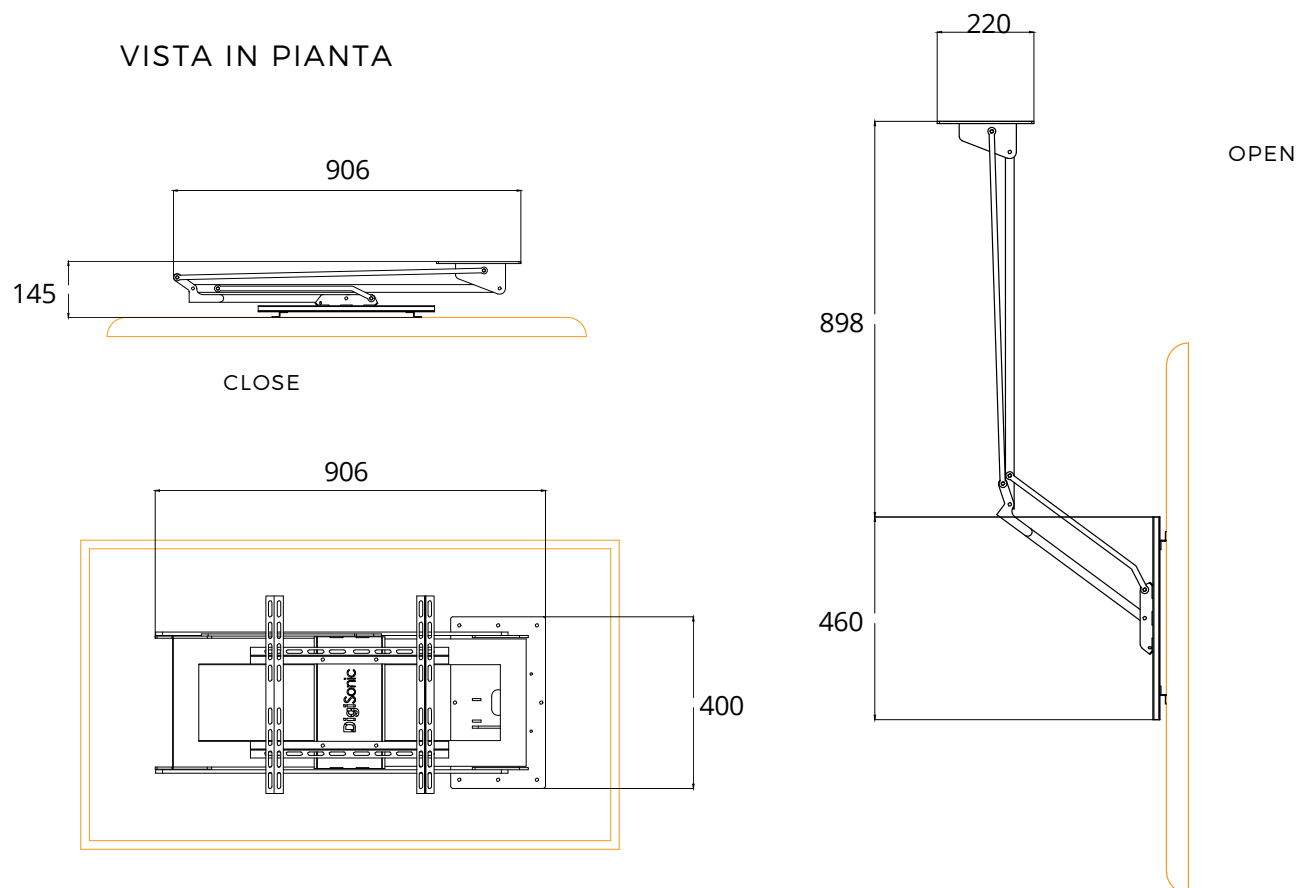

CLOSE

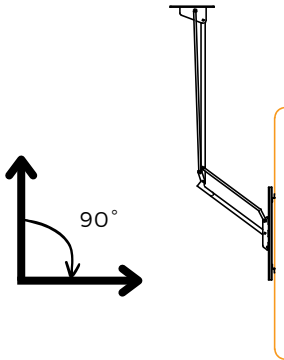
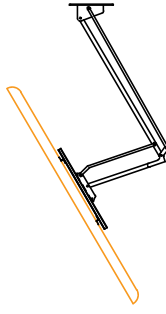
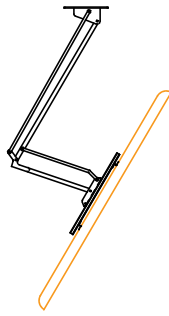
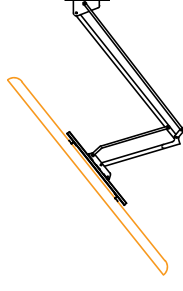
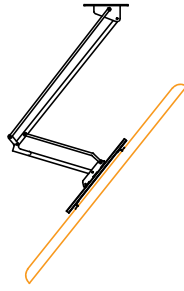
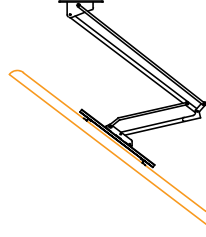
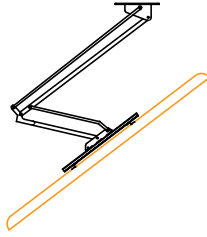
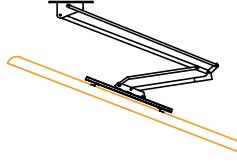
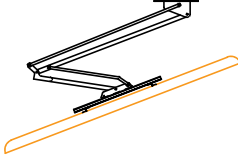
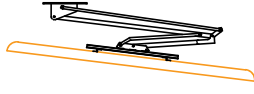
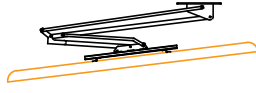

OPEN

**OPTION 1.** CONFIGURAZIONE DI APERTURA VERSO DESTRA

**OPTION 2.** CONFIGURAZIONE DI APERTURA VERSO SINISTRA

